

Incremental Iris Recognition: A Single-algorithm Serial Fusion Strategy to Optimize Time Complexity

Christian Rathgeb, Andreas Uhl and Peter Wild

Abstract—Daugman’s algorithm, mapping iris images to binary codes and estimating similarity between codes applying the fractional Hamming Distance, forms the basis of today’s commercially used iris recognition systems. However, when applied to large-scale databases, the linear matching of a single extracted iris-code against a gallery of templates is very time consuming and a bottleneck of current implementations. As an alternative to pre-screening techniques, our work is the first to present an incremental approach to iris recognition. We combine concentration of information in the first bits of an iris-code with early rejection of unlikely matches during matching stage to incrementally determine the best-matching candidate in the gallery. Our approach can transparently be applied to any iris-code based system and is able to reduce bit comparisons significantly (to about 5% of iris-code bits) while exhibiting a Rank-1 Recognition Rate being at least as high as for matches involving all bits.

I. INTRODUCTION

The human iris is emerging as the biometric of choice for high confidence authentication. Proposed approaches to iris recognition [1] report recognition rates above 99% and equal error rates less than 1%. Providing high accuracy iris recognition appears to be well suitable for access control systems managing large-scale user databases. Within identification systems, single iris-codes (probes) have to be matched against a database of iris-codes (gallery) requiring linear effort. In case databases comprise millions of iris-codes, without choice, biometric identification will lead to long-lasting response times. That is, reducing the computational effort of iris-based identification systems represents a challenging issue [2].

In recent work [3], it has been shown that the entropy of bits in iris-codes differs, depending on which parts of the iris texture these bits originate from. The inter-relation of local origin and consistency of bits in iris-codes defines a global distribution of reliability. We exploit this fact in order to accelerate iris biometric identification systems. From analyzing bit-error occurrences in a training set of iris-codes we estimate a global ranking of bit positions, based on which given probes are rearranged, i.e. iris-codes are reordered. With most reliable bits being arranged in the first part of an iris-code, we can now more successfully apply partial and incremental matching. The latter is a new technique, which incrementally computes Hamming Distance (HD) scores

between probe and gallery templates. Based on the outcome of partial matching, candidates with high HD scores are rejected dynamically. By this means, we gain performance with respect to computational effort as well as recognition accuracy. Representing a single-algorithm fusion technique the proposed system is generic and applicable to existing iris-code databases. In experimental studies, we investigate trade-offs between the accuracy and computational effort of different iris recognition algorithms. Obtained results confirm the soundness of the proposed approach.

The remainder of this paper is organized as follows: in Sect. II a brief summary of related work is given. Subsequently, the proposed system is described in detail in Sect. III. In Sect. IV experiments are presented and discussed. Sect. V concludes this work.

II. RELATED WORK

Recent work of Hollingsworth *et al.* [3] has shown that distinct parts of iris textures reveal more constant features (bits in the iris-code) than others. In other words, distinct parts of iris-codes turn out to be more consistent than others. This is because some areas within iris textures are more likely to be occluded by eyelids or eyelashes. Additionally, parts of iris-codes which originate from analyzing the inner bands of iris textures are found to be more constant than parts which originate from analyzing the outer bands. The authors exploit this fact by ignoring user-specific “fragile” bits during matching, resulting in a significant performance gain.

In order to accelerate identification runtime, Gentile *et al.* [4] have suggested a two-stage iris recognition system in which a shortlist of the top ten candidates is estimated using so-called short length iris-codes (SLICs [2]). For a rather small testset (85 classes) experiments reveal a performance speedup of a factor of 12 in terms of bit comparisons. However, the SLIC top ten candidates did not contain the correct match in about 7% of the cases which cannot be overcome in the later stage, limiting the true positive rate to about 93% for the overall system.

Previous work [5] has presented a more generic approach for optimizing both, recognition and processing performance of multibiometric systems in identification mode. The proposed method exploits ranking capabilities of individual features by reducing the set of possible matching candidates at each iteration. When applied to hand-based modalities, the new system is as accurate as sum-rule based fusion of individual classifiers, but twice as fast as the best single classifier on 86 classes.

This work has been supported by the Austrian Science Fund, project no. L554-N15 and FIT-IT Trust in IT-Systems, project no. 819382.

C. Rathgeb, A. Uhl and P. Wild are with the Multimedia Signal Processing and Security Lab (WaveLab), Department of Computer Science Sciences, University of Salzburg, A-5020 Salzburg, Austria
{crathgeb, uhl, pwild}@cosy.sbg.ac.at

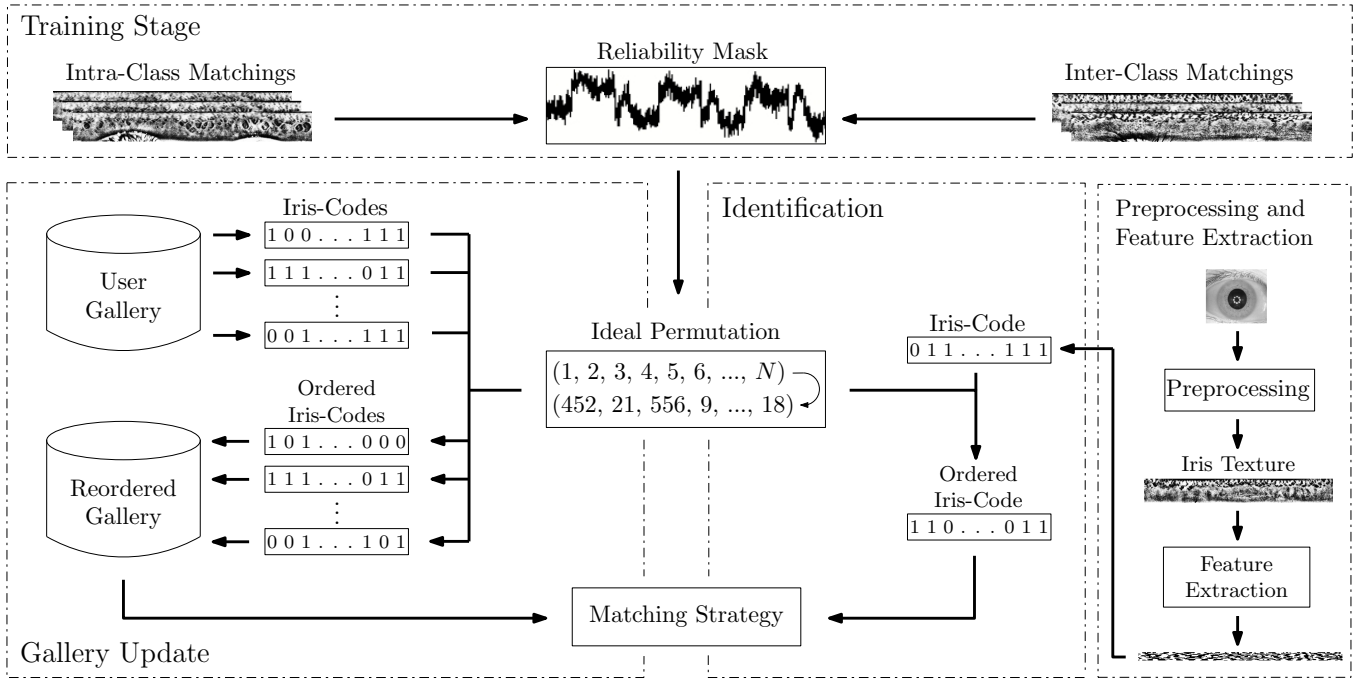

Fig. 1. System Architecture: the basic operation mode of the proposed system which comprises a training stage, gallery update and identification.

III. SYSTEM ARCHITECTURE

In order to apply incremental iris recognition, it is necessary to (1) obtain an ideal permutation of iris bits from a training stage, (2) perform a gallery update and (3) modify the module implementing the matching strategy. All these tasks and underlying system components are illustrated in Fig. 1 and described in more detail as follows.

A. Preprocessing and Feature Extraction

In the preprocessing step, pupil and iris of a given sample are detected by applying Canny edge detection and Hough circle detection. After localizing the pupil and iris circles, the area between them is transformed to a normalized rectangular texture of 512×64 pixel, according to the “rubbersheet” approach by Daugman. As a final step, lighting across the texture is normalized using blockwise brightness estimation.

In the feature extraction stage, we employ custom implementations of two different algorithms extracting binary iris-codes. The first one was proposed by Ma *et al.* [6]. Within this approach the texture is divided into stripes to obtain 10 one-dimensional signals, each one averaged from the pixels of 5 adjacent rows (the upper 512×50 are analyzed). A dyadic wavelet transform is then performed on each of the resulting 10 signals, and two fixed subbands are selected from each transform resulting in a total number of 20 subbands. In each subband all local minima and maxima above an adequate threshold are located, and a bitcode alternating between 0 and 1 at each extreme point is extracted. Using 512 bits per signal, the final code is then $512 \times 20 = 10240$ bit. The second feature extraction

method follows an implementation by Masek¹ in which filters obtained from a Log-Gabor function are applied. Here, a row-wise convolution with a complex Log-Gabor filter is performed on the texture pixels. The phase angle of the resulting complex value for each pixel is discretized into 2 bits. Again, row-averaging is applied to obtain 10 signals of length 512, where 2 bits of phase information are used to generate a binary code, consisting of $512 \times 20 = 10240$ bit. The algorithm is somewhat similar to Daugman’s use of Log-Gabor filters, but it works only on rows as opposed to the 2-dimensional filters used by Daugman. Different algorithms require separate training stages to determine reliable bits.

B. Training Stage and Gallery Update

Based on the idea that distinct parts of iris-codes contain more constant bits than others, we try to approximate a global reliability mask in the training stage. For a training set of n different classes U_i of iris images, where each class contains k iris images, $n \cdot k \cdot (k - 1)/2$ intra-class matchings and $k \cdot n \cdot (n - 1)/2$ inter-class matchings (for balancing reasons we only compare templates with equal indices within a class) are performed. Prior to estimating the error probability for each bit position, we estimate a perfect alignment by tolerating 7 shifts of the second iris-code for each matching pair. Subsequently, for each bit position the probabilities of intra-class and inter-class error occurrence are estimated, denoted by P_{Intra} and P_{Inter} , respectively. The reliability at each bit position is defined by $R = P_{Intra} - P_{Inter}$. Reliability measures of all bit positions over all pairings define a global (user-independent) reliability distribution, which is used to

¹L. Masek: Recognition of Human Iris Patterns for Biometric Identification, Master’s thesis, University of Western Australia, 2003

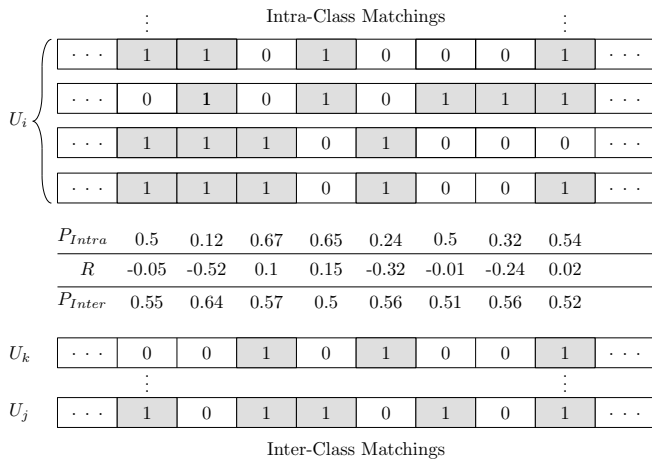

Fig. 2. Reliability mask construction: probabilities of intra-class and inter-class error occurrence are estimated to calculate the reliability at each bit position.

rearrange given iris-codes in ascending order with respect to bit reliability (small values indicate high reliability). A schematical impression of this process is shown in Fig. 2.

Once the reliability mask is calculated, iris-codes of a given user gallery are updated. From the previously calculated reliability mask an ideal permutation of bit positions is derived and applied to reorder all enrollment samples such that the first bits represent the most reliable bits and the last bits represent the least reliable bits.

C. Identification and Matching Strategies

Matching is executed in the transformed domain of reordered iris-codes. If galleries of original iris-codes are updated as outlined above, also each probe needs to be permuted before matching. However, due to this modification, the iris-code loses its property to tolerate rotational variance with simple bit-shifts. But this problem can be targeted by preparing correctly shifted variants using the inverse permutation.

In experiments we test two types of matching strategies:

- *Partial matching*: this method involves a traditional determination of the fractional HD, but restricts codes to a certain length. By this means, the amount of bit comparisons - and therefore time complexity - can be controlled exactly at the cost of possible degradation of matching accuracy. In case the reliability mask can successfully identify non-reliable bits over different users we can even expect to gain performance [3]. In order to assess the effect of reliability masks we test three types of permutations: *Original* refers to the identity permutation, i.e. partial matching on the unaltered iris-code, *Random* refers to a random permutation and *Sorted* uses the introduced ideal permutation.
- *Incremental matching*: this new technique illustrated in Fig. 3 performs partial matching of the probe with each gallery template for a given window size. After having obtained all partial HDs for a window, they

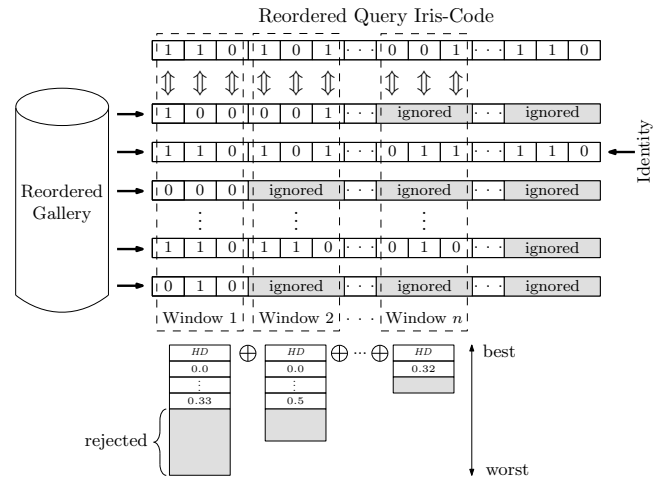

Fig. 3. Incremental iris matching: HD is incrementally calculated allowing early rejection of unlikely matches.

are combined with the corresponding HDs from previous windows (incremental computation) and all gallery templates are ordered according to their HD. Only candidates with a high chance for being the correct identity are kept, rejected candidates are excluded from further computations. Parameters for this method are window sizes and the exclusion criterion.

The idea, that a cascade of classifiers at multiple stages rejects candidates is not new, e.g. Viola and Jones [7] use this technique for face detection. However, the proposed incremental matching is the first method to work on iris-codes and combining reliability masks with early rejection. Our approach may also be seen as a single-algorithm fusion technique operating on different parts of the iris texture [8]: since the fractional HD over a sum of adjoint windows corresponds to the sum of HDs of these windows, the proposed method is a sum-rule fusion of partial matching classifiers.

IV. EXPERIMENTAL STUDIES

In order to assess partial and incremental matching techniques, we employ the CASIA-V3-Interval² iris database consisting of good quality NIR illuminated indoor images with 320×280 pixel resolution. Examples of input and processed textures are illustrated as part of the system architecture in Fig. 1. For experiments, we considered left-eye images only yielding a total of 1307 out of 2655 instances. These images are partitioned into two sets:

- *Training-A*: 87 images of the first 10 classes for parameter estimation purposes;
- *Test-B*: 177 single-enrollment gallery images and 1043 probe images of the remaining 177 classes for closed-set identification experiments.

The following subsections will cover each a specific research question concerning the soundness of our approach.

²The Center of Biometrics and Security Research, CASIA Iris Image Database, <http://www.sinobiometrics.com>

A. Do reliability masks really concentrate more reliable information in the first bits of an iris-code?

After obtaining the reliability mask and ideal permutation from set *Training-A*, we test block-wise partial matching on set *Test-B*, see Figs. 4, 5 (10240-bit iris-codes are divided into 20 adjacent 512-bit blocks).

For the unaltered configuration (*Original*), bits in early 512-bit blocks tend to exhibit more information with respect to rank-1 recognition rate (RR-1) than later blocks, however there is no clear monotonicity for both algorithms. Indeed, if block size is further reduced, a typical sawtooth-pattern becomes visible as can be seen in the according reliability masks in Figs. 6,7 which define the reliability at each bit position, as previously described. It turns out, that reliable bits are not uniformly distributed (as observed in [3]), but rather follow a specific pattern. Experiments show, that this pattern can be learned by relatively few training samples (*Training-A* with 87 images) and reproduces the desired sorting behavior in a distinctive set (*Test-B*). Recognition rates for this partial matching variant (*Sorted*) stay rather high until about 50 percent of the iris-code (92-97% for Ma, 91-95% for Masek), and then rapidly decrease. When applying *Random* (partial matching using random permutation), we (1) obtain an almost equal RR-1 (92.3% with standard deviation 0.9 for Ma, 91.8% with standard deviation 1.0 for Masek) for each 512-bit block and (2) this rate is higher than for each other block in the original iris-code. Hence, if no training data is available random permutations are suggested.

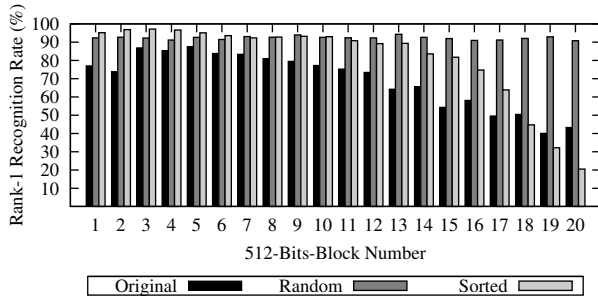

Fig. 4. RR-1 for 512-bit blocks for Ma (7 shifts) on *Test-B*.

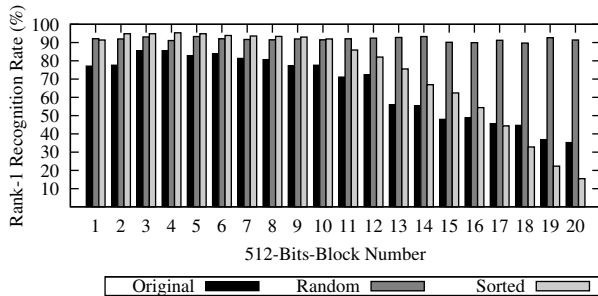

Fig. 5. RR-1 for 512-bit blocks for Masek (7 shifts) on *Test-B*.

B. How are reliable bits distributed over iris textures for different iris recognition algorithms?

We have seen, that reliability masks (see Figs. 6,7) indeed induce a ranking of bits for unseen iris-codes. In order to

check for similarities between masks for different algorithms, we have to re-map bit errors to the localized area of origin within the iris texture. Fig. 8 illustrates this back-mapping revealing similarities in the structure of different reliability masks and corresponding reliability textures.

The shape of reliability textures is quite expectable: since reliability masks are computed on the whole iris texture without considering iris masks, usually masked areas should exhibit many errors, while unmasked areas should be free of errors. A typical two-dome pattern of non-reliable bits with stable middle bands (as reported in [3]), especially for lower iris parts (right arm of the unrolled iris texture) probably due to less frequently occluding eyelashes, is clearly visible.

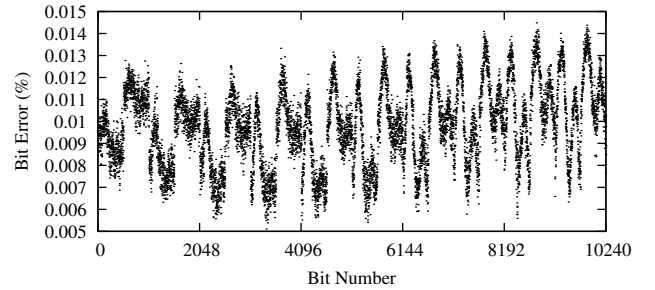

Fig. 6. Reliability mask for Ma on *Training-A*.

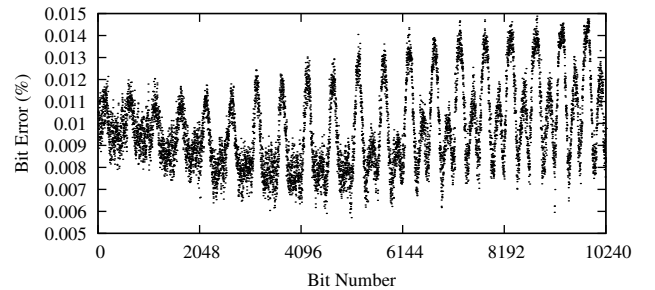

Fig. 7. Reliability mask for Masek on *Training-A*.

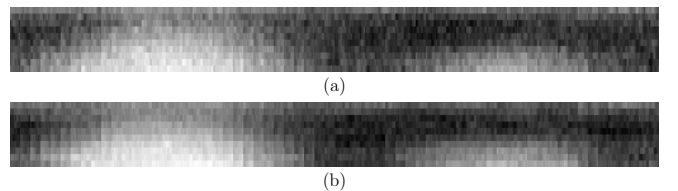

Fig. 8. Distribution of reliable bits: (a) reliability texture for Ma (b) reliability texture for Masek.

C. Does incremental iris recognition reduce matching time complexity at retaining high recognition accuracy?

We have tested incremental iris recognition using Ma and Masek's algorithms in 2 different shifting variants: 0 shifts and 7 shifts. Table I lists all rates for tested matching variants. For 0 shifts, *Incremental* is able to reduce the total number of bit comparisons to 3.2% at 82.7% RR-1 for Ma and to 3.8% at 87.7% RR-1 for Masek. The obtained recognition rates are even slightly better than for the *Original* reference using all bits (79.8% RR-1 for Ma and 86.8% RR-1 for Masek) due to the property of reliability masks to identify non-reliable bits. The 7 shifts variant draws a similar picture

TABLE I

RR-1 RATES OF PRESENTED MATCHING TECHNIQUES FOR DIFFERENT AMOUNTS OF BIT COMPARISONS ON TEST-B

RR-1 (Bits)		Ma		Masek	
		0 shifts	7 shifts	0 shifts	7 shifts
Original	All Bits	79.8	98.6	86.8	95.7
	1% Bits	19.4	19.2	20.5	18.4
	10% Bits	64.8	87.0	72.8	81.8
	Best RR-1 (Bits)	79.8	98.8	87.5	97.4
		(100%)	(70.7%)	(70.7%)	(70.7%)
Random	1% Bits	56.6	61.6	66.3	65.6
	10% Bits	76.0	96.5	85.0	95.2
	Best RR-1 (Bits)	79.8	98.6	87.0	95.9
		(100%)	(84.1%)	(59.5%)	(42.0%)
Sorted	1% Bits	69.8	77.9	66.7	67.5
	10% Bits	83.6	97.7	86.0	94.9
	Best RR-1 (Bits)	84.1	99.2	88.6	97.3
		(14.9%)	(35.4%)	(50.0%)	(70.7%)
Incremental	1% Bits	76.5	79.7	75.1	67.5
	Best RR-1 (Bits)	82.7	99.2	87.7	97.2
		(3.2%)	(4.8%)	(3.8%)	(5.0%)
	Non-partial (Bits)	81.0	99.1	87.6	97.2
		(5.1%)	(4.9%)	(3.9%)	(5.0%)

with *Incremental* reducing the number of bit comparisons to 4.8% at 99.2% RR-1 for Ma and 5.0% at 97.2% RR-1 for Masek (*Original* reference rates: 98.6% for Ma, 95.7% for Masek). These rates refer to best RR-1 performance varying the maximum amount of bits. But also in case of allowing all bits (non-partial) incremental iris recognition is a highly scalable technique.

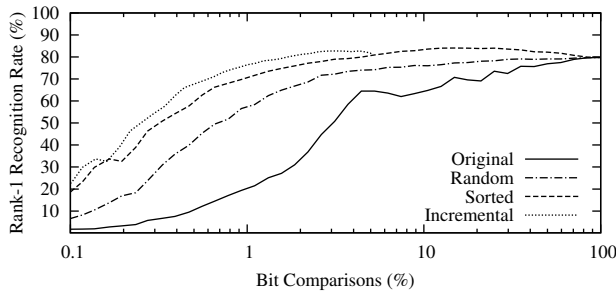

Fig. 9. Time complexity vs. Recognition accuracy for Ma (0 shifts).

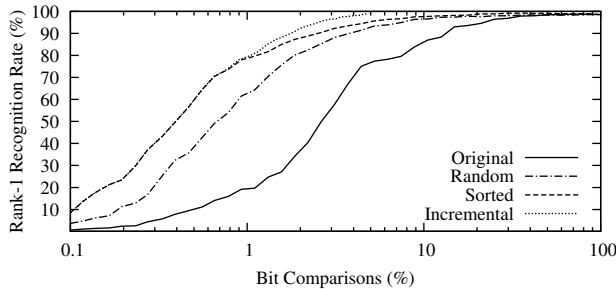

Fig. 10. Time complexity vs. Recognition accuracy for Ma (7 shifts).

D. Which tradeoff exists between time complexity and recognition accuracy for investigated time-scaling approaches?

The varying amount of bits to be matched for identification introduces a tradeoff between time complexity (in terms of bit comparisons) and recognition accuracy (RR-1), visualized in Figs. 9-12. This tradeoff also exists for incremental matching, since it is possible to abort the computation if a

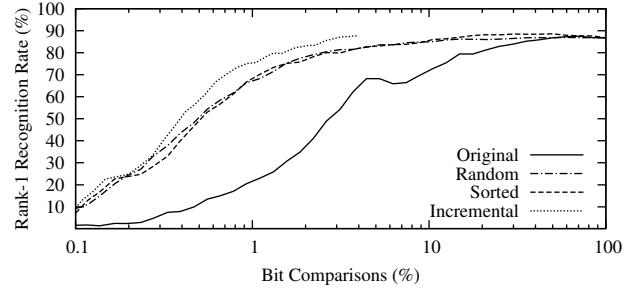

Fig. 11. Time complexity vs. Recognition accuracy for Masek (0 shifts).

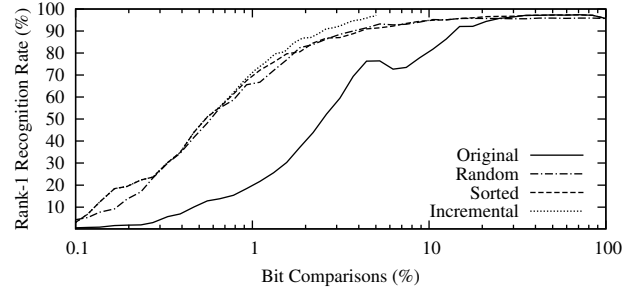

Fig. 12. Time complexity vs. Recognition accuracy for Masek (7 shifts).

certain amount of bits has been matched. In this configuration however, it is no longer possible to directly control the amount of bit comparisons, since the list of potential matches is reduced dynamically.

For partial iris matching, *Random* performs much better than *Original* over the entire range of bit comparisons and for all tested algorithm variants. With *Random* it is possible to reduce the amount of bit comparisons to about 10% without significant degradation in performance (maximum absolute RR-1 degradation less than 5% of the original value).

Even without reordering (*Original*), partial matching tolerates a loss off about 50% of the bits without degrading performance too much. But in this case, as can be seen from the graphs in Figs. 9-12, recognition rates decline rapidly if the amount of bits falls below 5%.

With reliability masks (*Sorted*), partial matching recognition rates can be further optimized and now even exceed *Original* match performance using all bits (1-5% higher RR-1 at 15-70% of bit comparisons, depending on the type of algorithm). This is the case, because the last bits in the code contain less discriminative information and may degrade total performance.

Finally, *Incremental* consequently delivers the highest savings in terms of bit comparisons, only about 5% of iris-code bits are required while all RR-1 values are at least as high as for a full iris-code match. However, additional savings by partial matching are negligible.

E. How to choose reasonable parameters for incremental iris recognition?

For incremental iris recognition there are two parameters: window sizes (positions within the iris-code where to combine and rank HD values), and exclusion criterion (EC).

Regarding the first parameter it turns out, that evaluations at positions with logarithmic spacing are well suited. This is

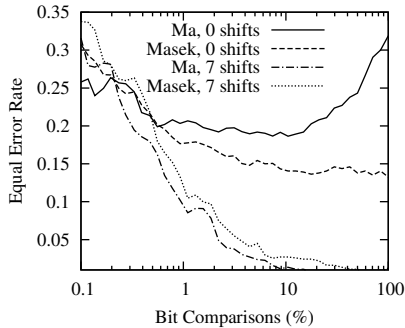

Fig. 13. Equal error rate depending on fraction of bit comparisons for Ma, Masek on *Training-A*.

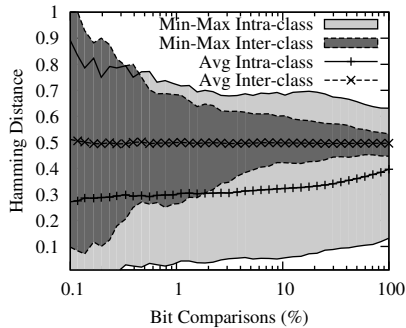

Fig. 14. Intra- and inter-class score distributions depending on bit comparisons for Ma (0 shifts).

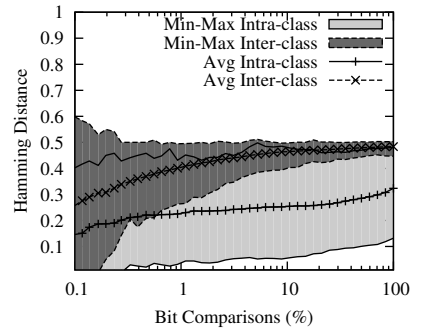

Fig. 15. Intra- and inter-class score distributions depending on bit comparisons for Ma (7 shifts).

because the RR-1 is sensitive to small changes for few bit comparisons, while tolerating larger changes if a high amount of bits is available. Also the additional worst case ranking overhead per match is in $O(\log(n) * r)$ where n refers to the (partial) iris-code length and r is the time amount required to combine, resort and reject HD measures.

In case of the second parameter, a natural approach is to define a maximum tolerance of HD deviation of candidate x with sample s from the best-matching candidate b at i percent of bit comparisons:

$$EC_i(x) := \begin{cases} \text{keep} & \text{if } HD_i(x, s) - HD_i(b, s) < \eta_i, \\ \text{reject} & \text{otherwise.} \end{cases} \quad (1)$$

Performance as well as intra- and inter-class scores depend on the amount of bit comparisons, see Figs. 13-15. This way, at each iteration step in the incremental computation, we assess the probability that the current template may finally end up with a smaller HD value than the current best-matching candidate. An adequate choice for η_i is:

$$\eta_i := \frac{\max_{(a,b) \in G} |HD_i(a, b) - HD_{50}(a, b)| + \text{avg}_{(a,b) \in I} |HD_i(a, b) - HD_{50}(a, b)|}{2} \quad (2)$$

obtained from intra-class matches G and inter-class matches I in set *Training-A*. Note, that as reference rate we selected the outcome after 50% of the iris-code to account for non-reliable bits (see Fig. 13).

While there may be other (user-dependent) parameters achieving even higher savings in processing time, the presented choice is a straight-forward approach and only small training data is needed to produce stable results. However, the choice of suitable parameters is still an interesting point to work on and will be subject to future research in this area.

V. SUMMARY AND CONCLUSION

Several years of research have proven the accuracy and practicality of iris recognition [1]. While proposed approaches reach a high level of maturity with respect to recognition rates, performing identification on large-scale user galleries requires exhaustive linear search. In order to overcome system bottlenecks recent research has been focused on reducing computational effort in iris-based identification systems [4].

In this work we presented a generic approach to optimize time complexity of biometric identification employing different iris recognition algorithms. From a training set of iris images we derive a global distribution of reliability over each single bit position of iris-codes, based on which operational galleries of enrollment samples are reordered. By analogy, bits of acquired iris-codes are permuted, such that template matching, for which we propose a partial and an incremental strategy, is highly accelerated in a single-algorithm serial fusion scenario. The proposed technique offers significant advantages over conventional bit-masking, which would represent binary reliability masks. Reliability masks are global and therefore applicable to all users. Thus, memory is saved (single mask per algorithm) while matching procedures remain unaltered for each pair-wise comparison. Furthermore, reliability masks define a precise ranking of bits in iris-codes, rather than ignoring parts of iris textures. In our experiments we demonstrate that by applying the proposed approach we are capable of reducing the overall bit comparisons to about 5% (!) while maintaining or even increasing recognition performance.

REFERENCES

- [1] K. W. Bowyer, K. Hollingsworth, and P. J. Flynn, "Image understanding for iris biometrics: A survey," *Computer Vision and Image Understanding*, vol. 110, no. 2, pp. 281 – 307, 2008.
- [2] J. E. Gentile, N. Ratha, and J. Connell, "SLIC: Short Length Iris Code," in *BTAS'09: Proceedings of the 3rd IEEE International Conference on Biometrics: Theory, Applications and Systems*, Piscataway, NJ, USA, 2009, pp. 171–175, IEEE Press.
- [3] K. P. Hollingsworth, K. W. Bowyer, and P. J. Flynn, "The best bits in an iris code," *IEEE Transactions on Pattern Analysis and Machine Intelligence*, vol. 31, no. 6, pp. 964–973, 2009.
- [4] J. E. Gentile, N. Ratha, and J. Connell, "An efficient, two-stage iris recognition system," in *BTAS'09: Proceedings of the 3rd IEEE International Conference on Biometrics: Theory, Applications and Systems*, Piscataway, NJ, USA, 2009, pp. 211–215, IEEE Press.
- [5] A. Uhl and P. Wild, "Parallel versus serial classifier combination for multibiometric hand-based identification," in *Proceedings of the 3rd International Conference on Biometrics 2009 (ICB'09)*, 2009, vol. 5558 of *LNCS*, pp. 950–959, Springer Verlag.
- [6] L. Ma, T. Tan, Y. Wang, and D. Zhang, "Efficient iris recognition by characterizing key local variations," *IEEE Transactions on Image Processing*, vol. 13, no. 6, pp. 739–750, 2004.
- [7] P. Viola and M. J. Jones, "Robust real-time face detection," *International Journal of Computer Vision*, vol. 57, no. 2, pp. 137–154, 2004.
- [8] A. Ross, K. Nandakumar, and A. K. Jain, *Handbook of Multibiometrics*, Springer, 2006.